



# Installation instructions, accessories

Volvo Car Corporation Gothenburg, Sweden

Instruction No	Version	Part. No.
31470001	1.2	31435696

## Dirt cover, load compartment, fully covering



# Installation instructions, accessories

Volvo Car Corporation Gothenburg, Sweden

## Equipment

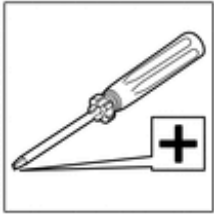

IMG-405465

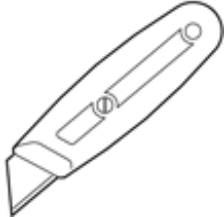

IMG-239980

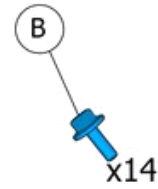
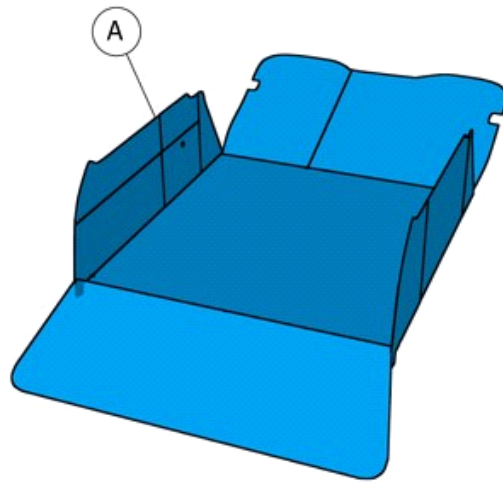

IMG-421255



# Installation instructions, accessories

Volvo Car Corporation Gothenburg, Sweden

## Information

1

Read through all of the instructions before starting installation.

Notifications and warning texts are for your safety and to minimise the risk of something breaking during installation.

Ensure that all tools stated in the instructions are available before starting installation.

Certain steps in the instructions are only presented in the form of images. Explanatory text is also given for more complicated steps.

In the event of any problems with the instructions or the accessory, contact your local Volvo dealer.

## Color symbols

2

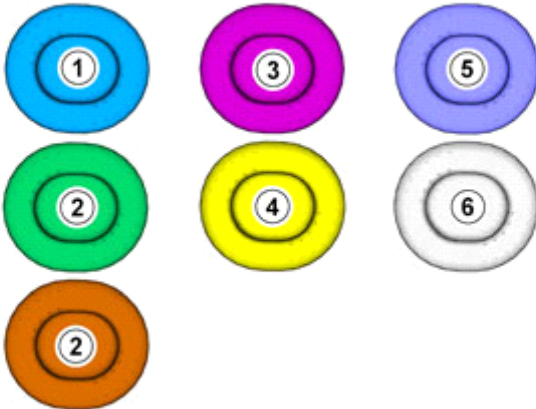

IMG-363036

### Note!

This colour chart displays (in colour print and electronic version) the importance of the different colours used in the images of the method steps.

- Used for focused component, the component with which you will do something.
- Used as extra colors when you need to show or differentiate additional parts.
- Used for attachments that are to be removed/installed. May be screws, clips, connectors, etc.
- Used when the component is not fully removed from the vehicle but only hung to the side.
- Used for standard tools and special tools.
- Used as background color for vehicle components.

## Preparation



# Installation instructions, accessories

Volvo Car Corporation Gothenburg, Sweden

3

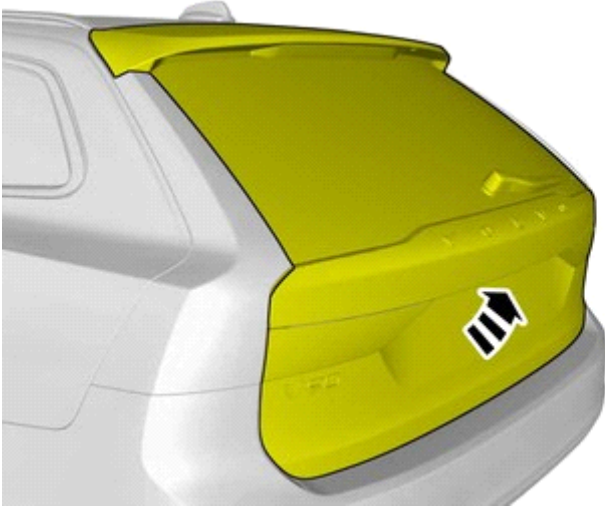

IMG-407110

4

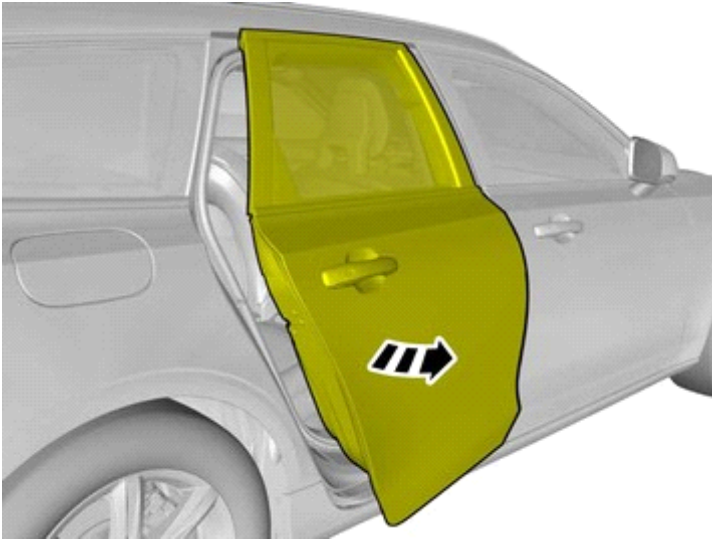

IMG-415787

## Accessory installation



# Installation instructions, accessories

Volvo Car Corporation Gothenburg, Sweden

5

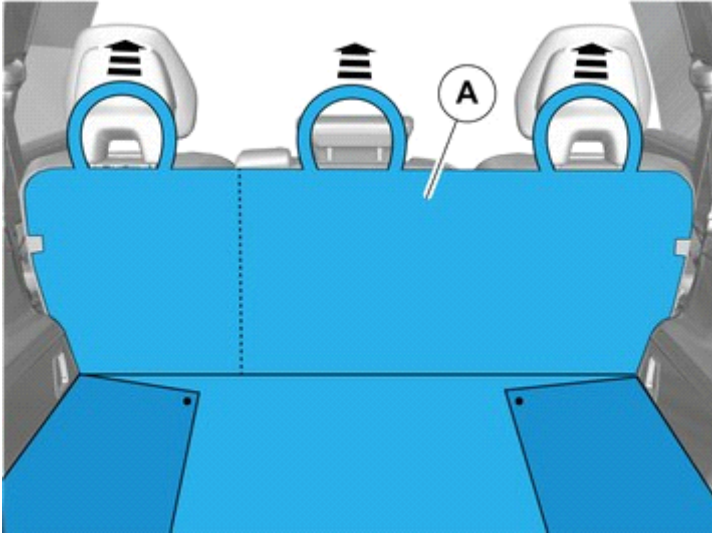

IMG-421253

Install component that comes with the accessory kit.

6



IMG-411070

7

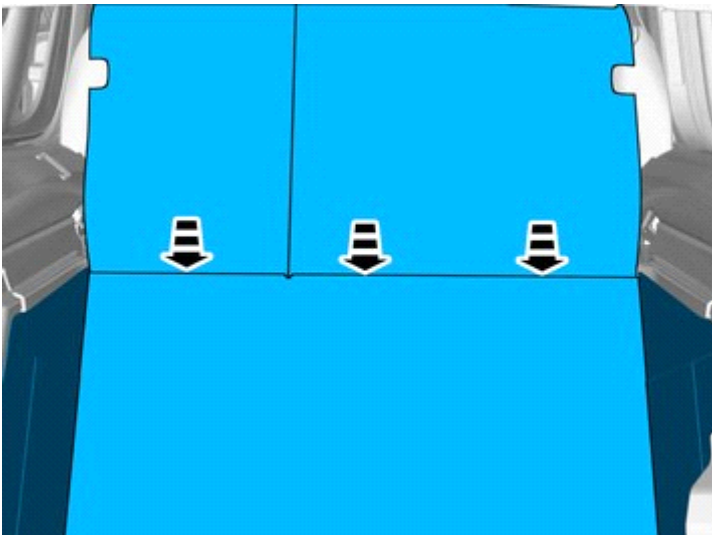

IMG-420225

**Note!**  
Note the position.

Place the component where indicated in the graphic.



# Installation instructions, accessories

Volvo Car Corporation Gothenburg, Sweden

8

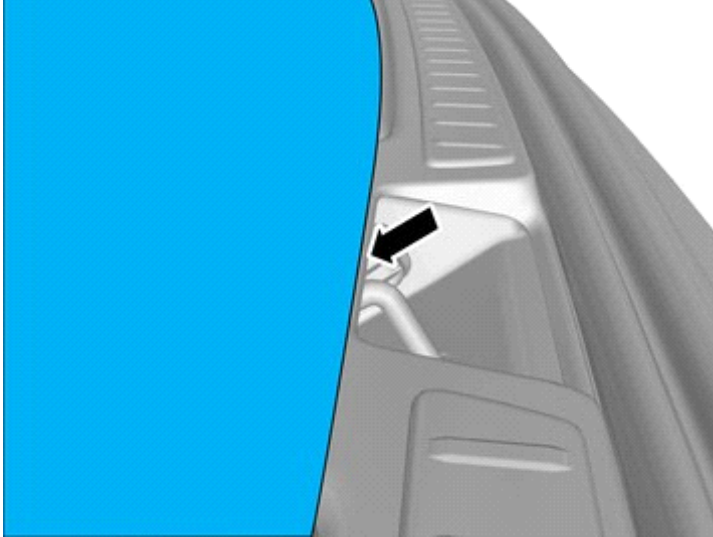

IMG-408848

**Note!**

Note the position.

Place the component where indicated in the graphic.

9

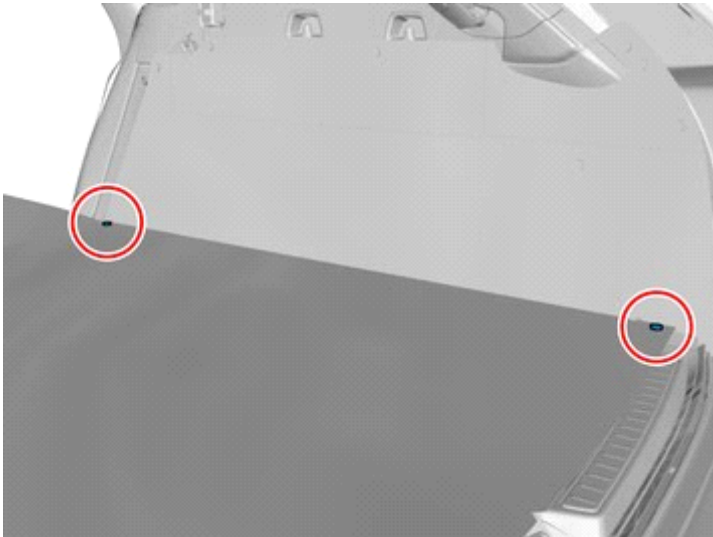

IMG-420925

**Note!**

Orientation view

10

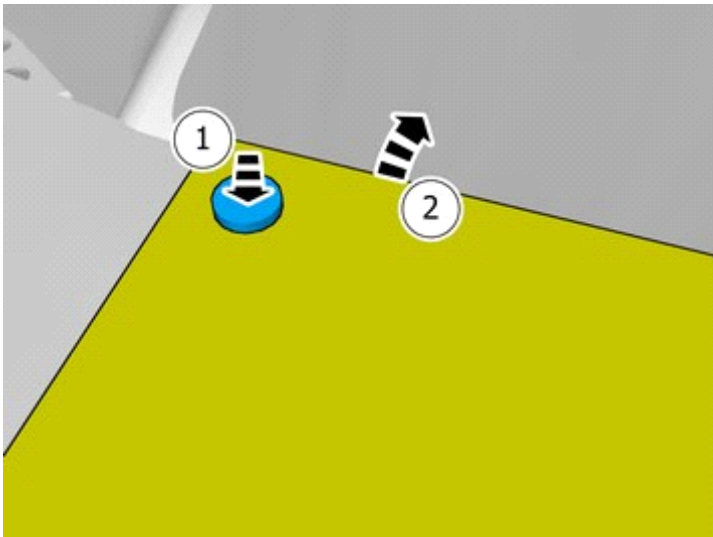

IMG-420926

- Press the marked component.
- Fold marked part to one side.



# Installation instructions, accessories

Volvo Car Corporation Gothenburg, Sweden

11

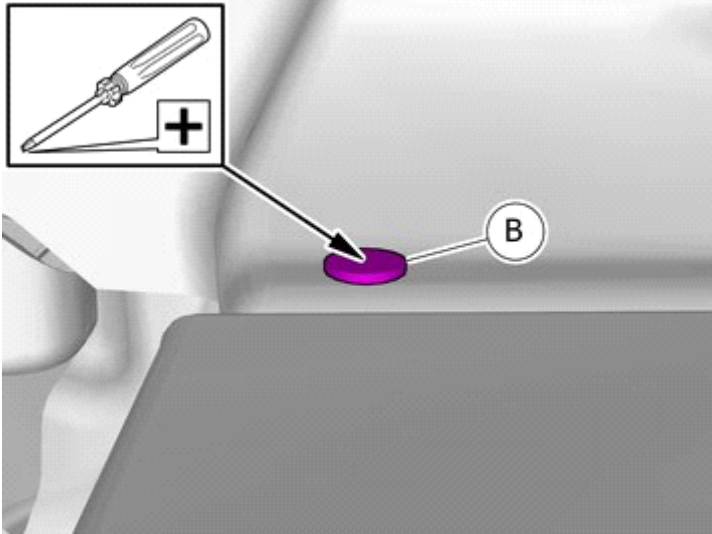

IMG-420930

Install component that comes with the accessory kit.

Tighten the screw.

12

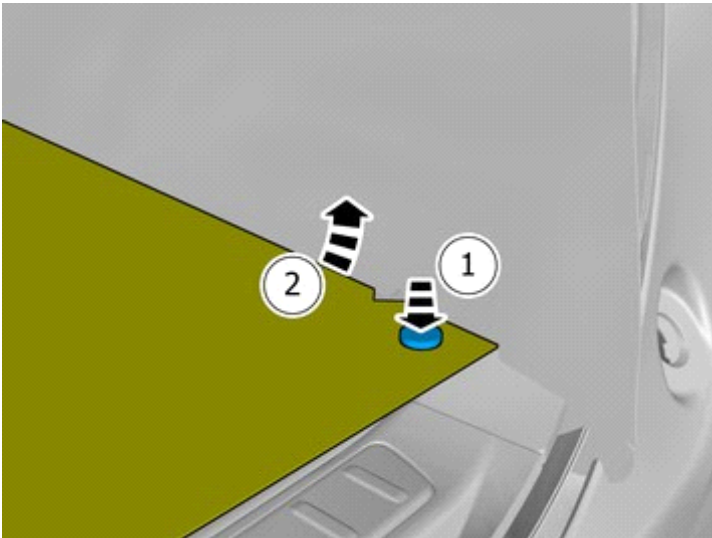

IMG-420931

Press the marked component.

Fold marked part to one side.



# Installation instructions, accessories

Volvo Car Corporation Gothenburg, Sweden

13

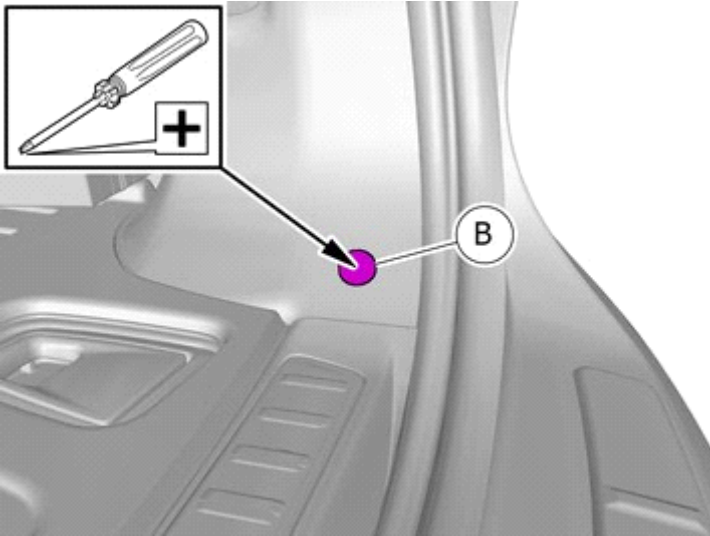

IMG-420932

Install component that comes with the accessory kit.

Tighten the screw.

14

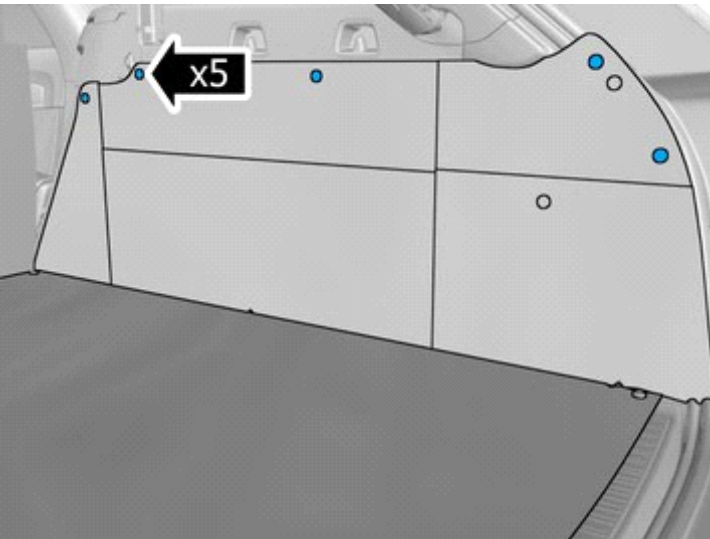

IMG-420824

**Note!**  
Orientation view

15

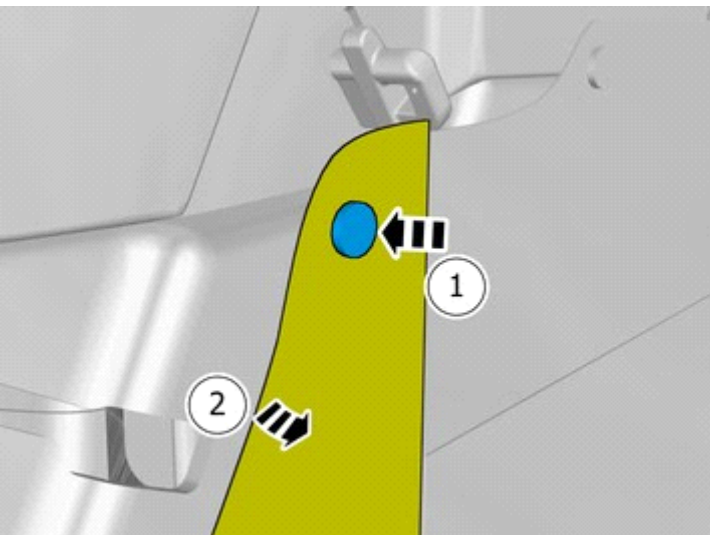

IMG-420933

- Press the marked component.
- Fold marked part to one side.





# Installation instructions, accessories

Volvo Car Corporation Gothenburg, Sweden

16

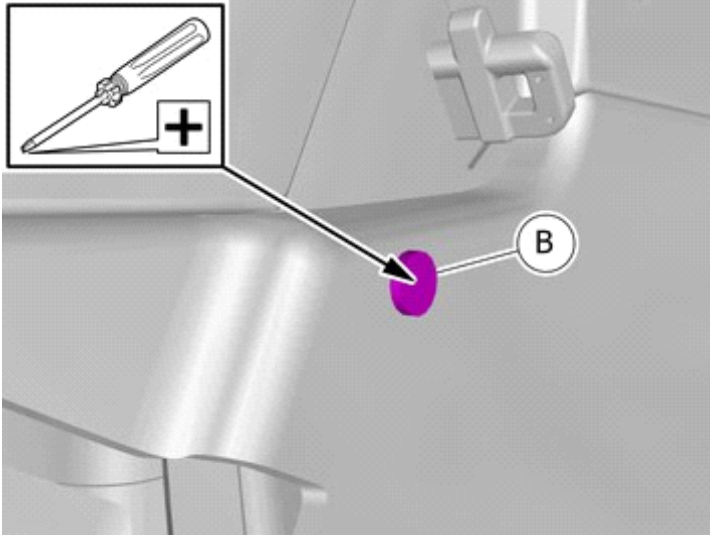

IMG-420934

Install component that comes with the accessory kit.

Tighten the screw.

17

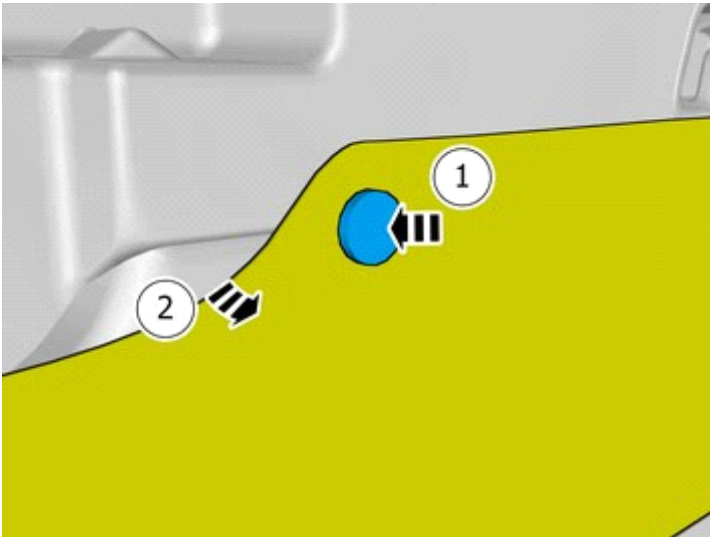

IMG-420940

Press the marked component.

Fold marked part to one side.

18

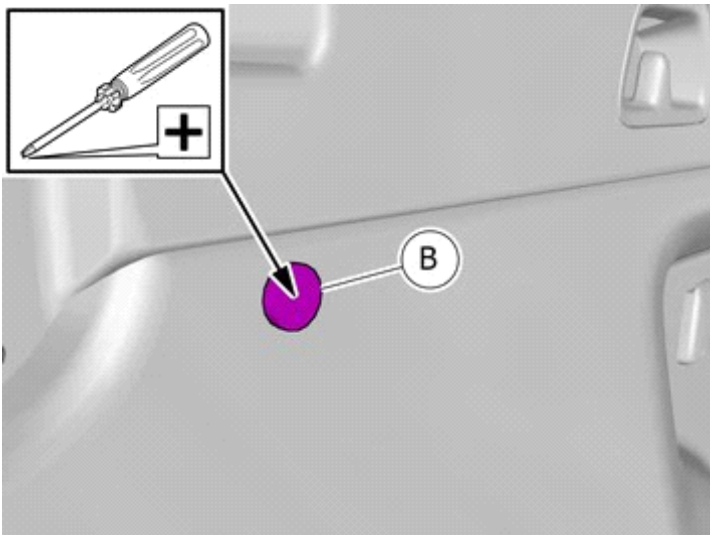

IMG-420941

Install component that comes with the accessory kit.

Tighten the screw.



# Installation instructions, accessories

Volvo Car Corporation Gothenburg, Sweden

19

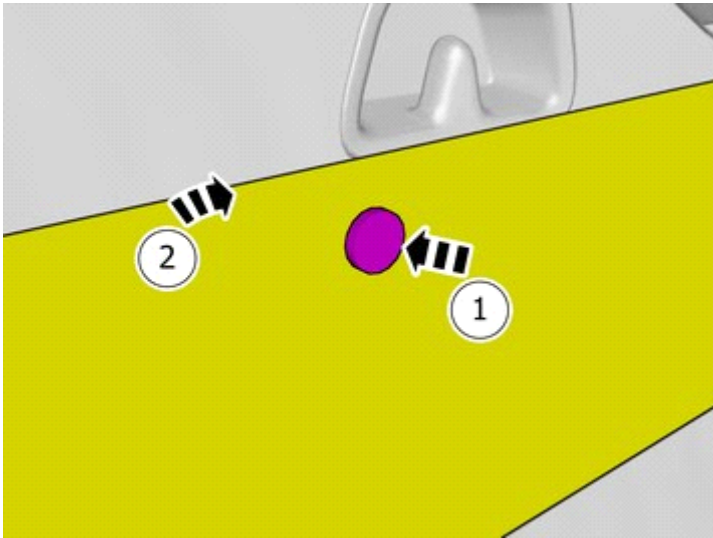

IMG-420942

- Press the marked component.
- Fold marked part to one side.

20

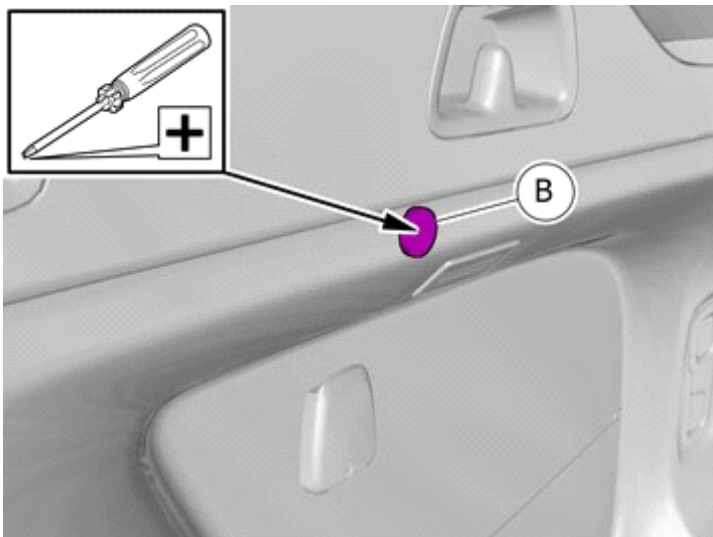

IMG-420943

- Install component that comes with the accessory kit.
- Tighten the screw.



# Installation instructions, accessories

Volvo Car Corporation Gothenburg, Sweden

21

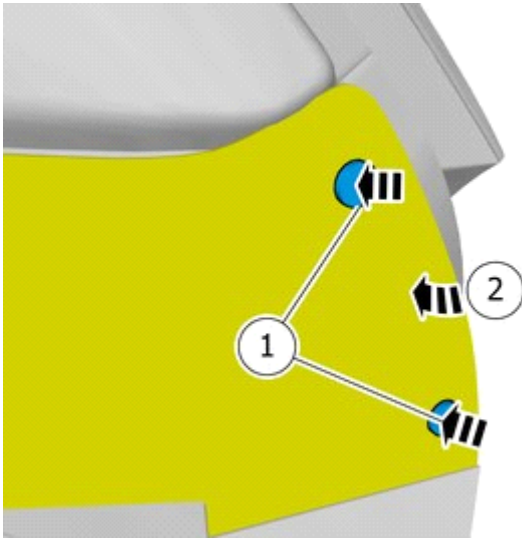

IMG-420948

- Press the marked component.
- Fold marked part to one side.

22

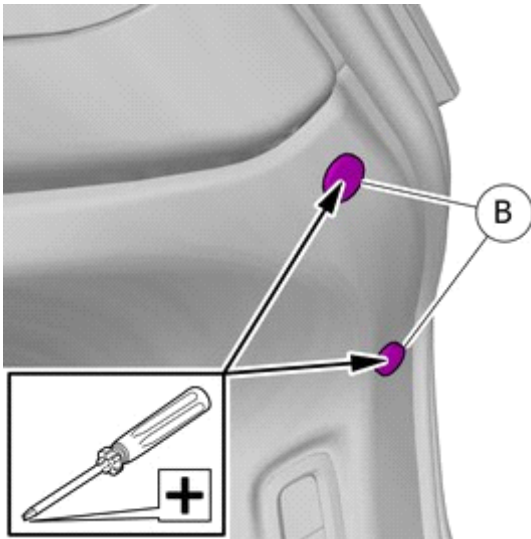

IMG-420949

- Install component that comes with the accessory kit.
- Tighten the bolts.

23

Repeat all method steps for the other side.

24

To access cargo anchor.



# Installation instructions, accessories

Volvo Car Corporation Gothenburg, Sweden

25

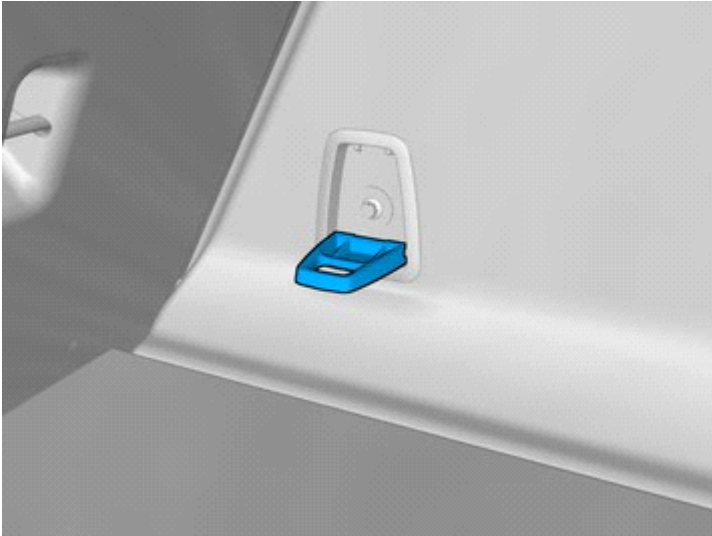

IMG-421290

**Note!**  
Orientation view

26

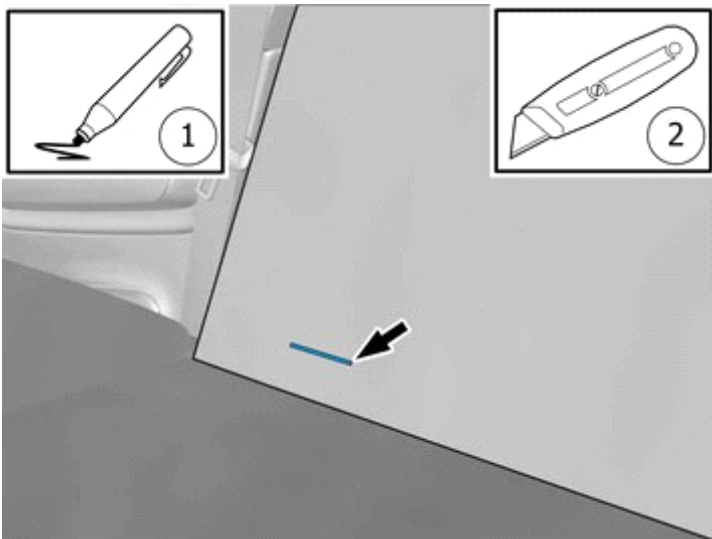

IMG-420802

- Measure and mark as illustrated.
- Cut the component following the instructions in the graphic.

27

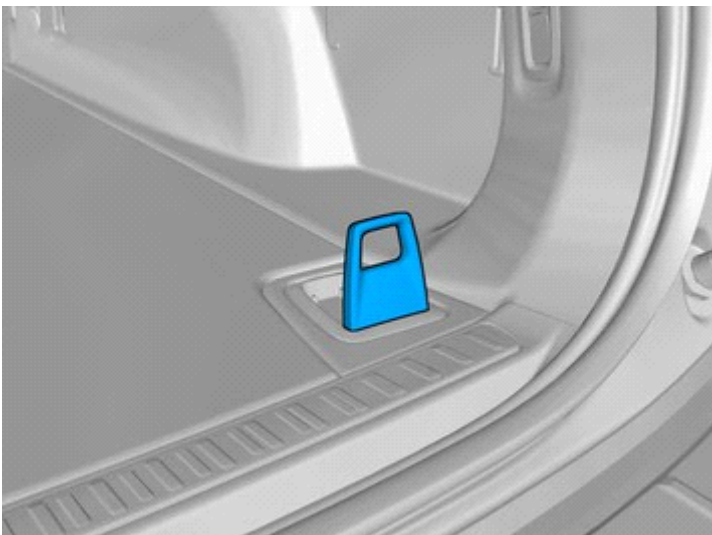

IMG-421216

**Note!**  
Orientation view



# Installation instructions, accessories

Volvo Car Corporation Gothenburg, Sweden

28

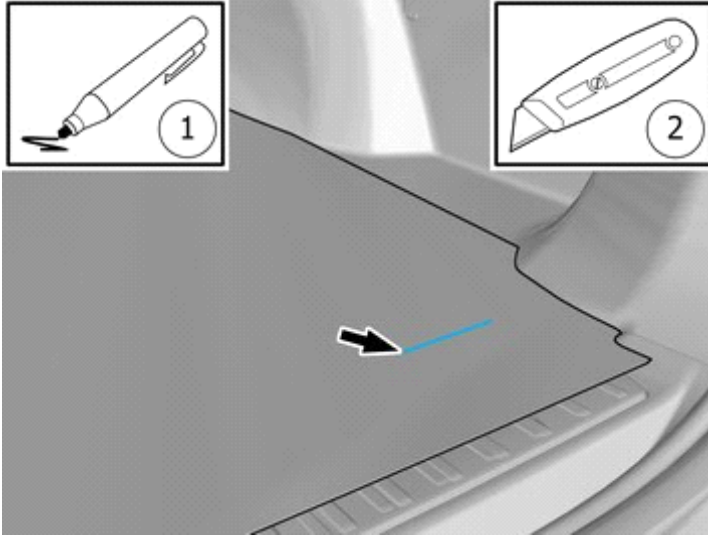

IMG-421217

- Measure and mark as illustrated.
- Cut the component following the instructions in the graphic.

29

Repeat all method steps for the other side.

## Vehicles with longitudinal load compartment divider

30

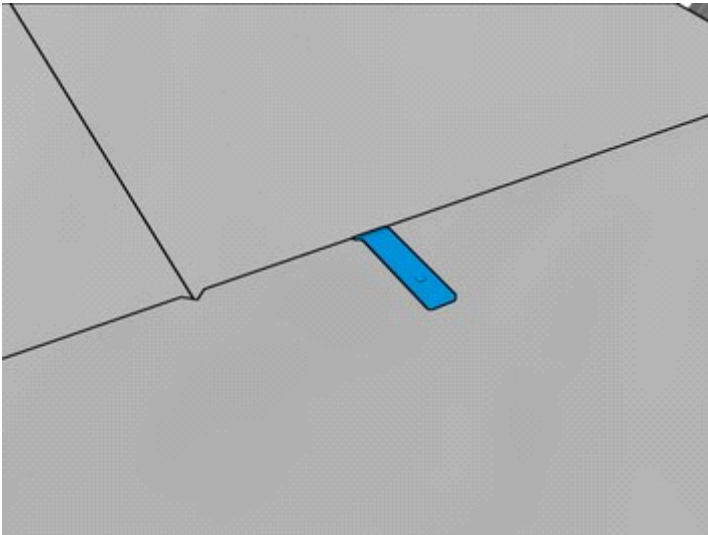

IMG-420686

**Note!**  
Orientation view



# Installation instructions, accessories

Volvo Car Corporation Gothenburg, Sweden

31

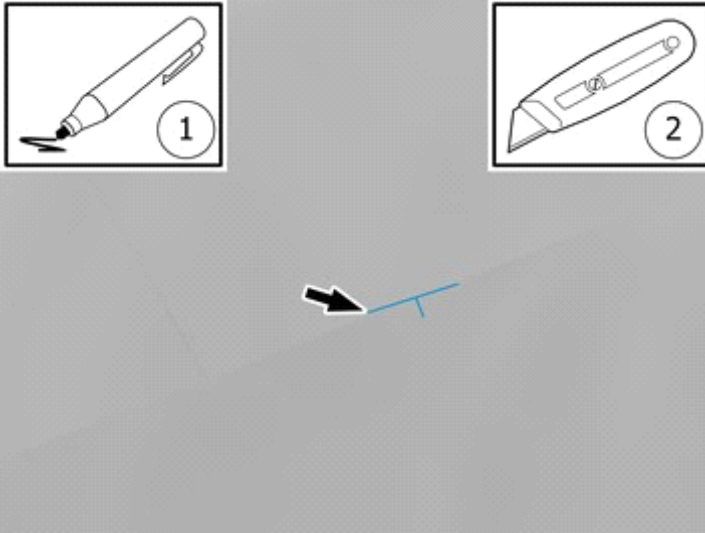

IMG-420690

- Measure and mark as illustrated.
- Cut the component following the instructions in the graphic.

32

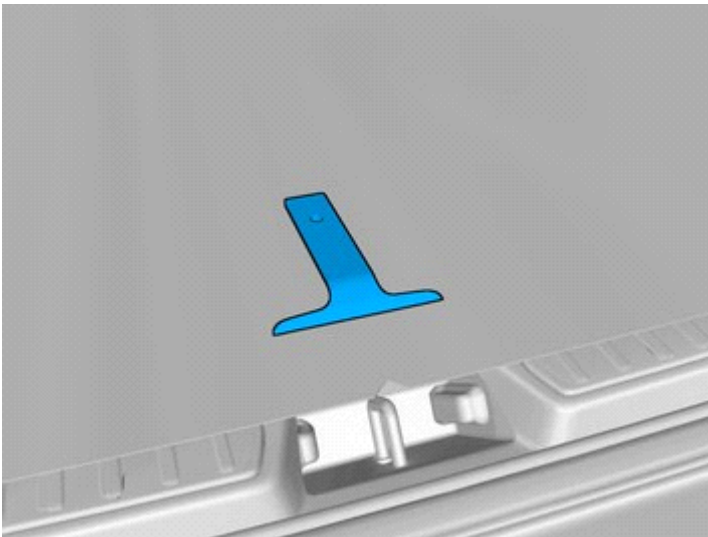

IMG-420684

**Note!**  
Orientation view

33

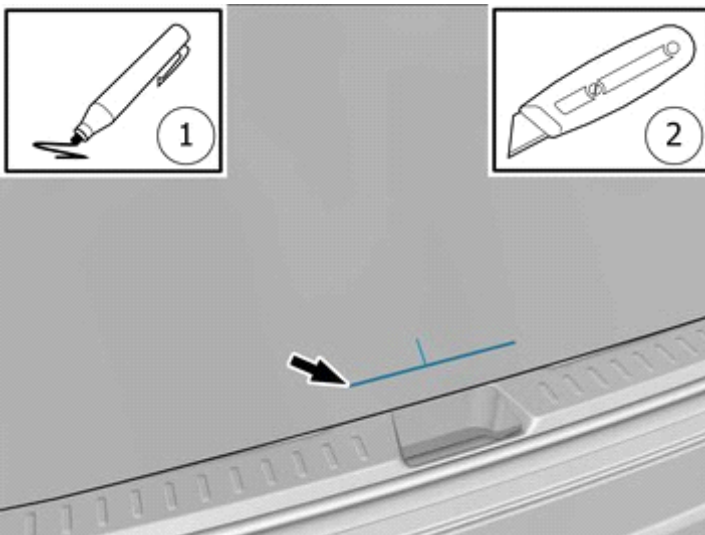

IMG-420685

- Measure and mark as illustrated.
- Cut the component following the instructions in the graphic.



# Installation instructions, accessories

Volvo Car Corporation Gothenburg, Sweden

## Alternative 1

34

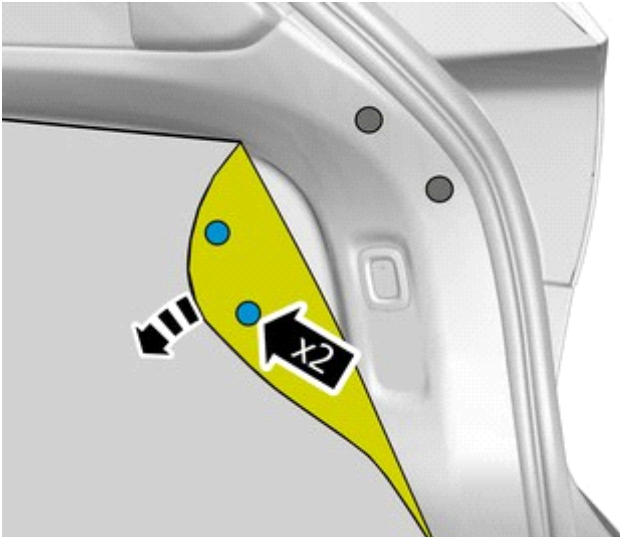

IMG-421317

## Alternative 2

35



IMG-421316

## All vehicles



# Installation instructions, accessories

Volvo Car Corporation Gothenburg, Sweden

36

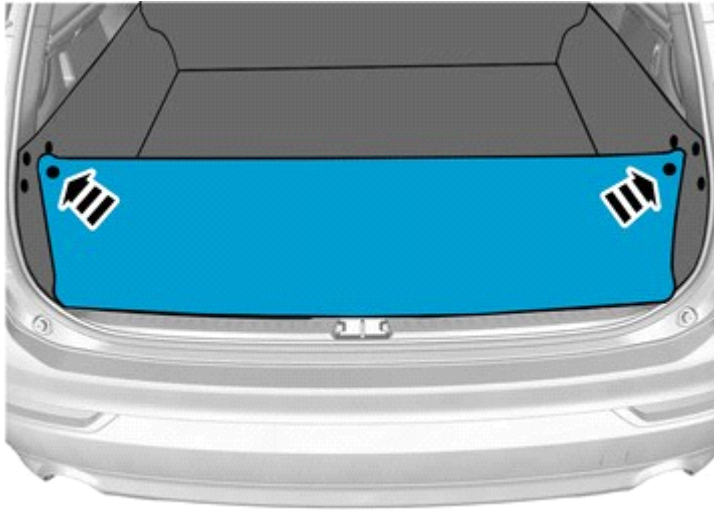

Allow the Bumper Protection to adhere to the Bumper Cover as indicated.

IMG-409475